

91.08011 Surface Mounted Lighting

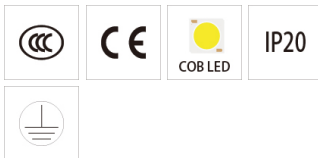
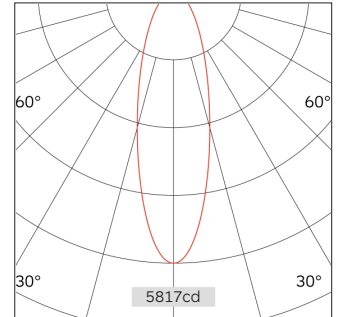
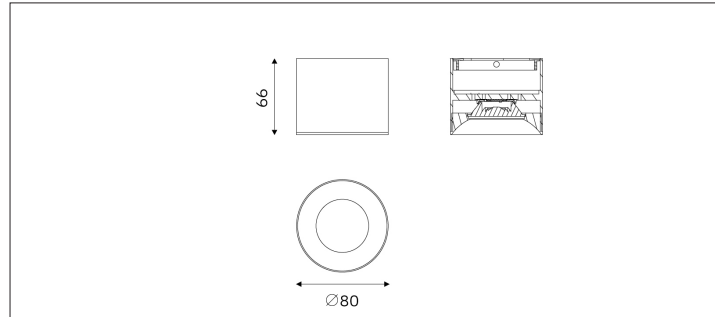

Light Distribution	Surface Mounted Lighting
Colour Temperature	2700/3000/3500/4000K
Colour Rendition Index	CRI 90
Optics	LENS
Beam Angle	13D/22D/32D/62D
Installation method	Surface Mounted
Connected Load	10W
Luminous Flux Of The Luminaire	819lm
Luminaire Efficacy	79lm/W
Colour Deviation	SDCM < 5
Light Source	LED
LED Type	COB
Dimming Method	Triac/1-10V/ Dali
Cover Material	Aluminum
Body Material	Aluminum
IP Rating	IP20
Housing Colour	Sandy White/ Sandy Black
Weight	0.68Kg
Technical Region	220-240V 50/60Hz

Light Beam Talbe		
h(m)	E(lx)	D(m)
		22°
1.0	4416	0.38
2.0	1104	0.77
3.0	490	1.15
4.0	276	1.53
5.0	176	1.91

Mainly used in high-end commercial space (clothing shops, furniture shops and other brand boutiques, car displays, jewelry, star hotels, highend clubs, museums, chain stores, brand sales halls, professional windows, counters and other accent lighting places).